

( )

\*

( // : // : )

( )%

/ m/s

°C

% /

/

/

:

( )

( )

( )

" :

" "

" "

"

( )

( )

( )

/ m

/ °C

( a)

---

4. Artificial Neural Network  
5. Feedback

- 
1. Dried Zone
  2. Drying Zone
  3. Undried Zone

- 
- 4. Soft Computing
  - 5. Learning
  - 6. Neuron
  - 7. Training
  - 8. Noise

- 
- 1. Levenberg-Marquardt
  - 2. Radial Basis Function
  - 3. Multi Layer Perceptron

(MLP)

( )

RBF

( )

(MLP)

(RBF)

" "

( )

( ) (

)

" "

/

...

:

n

(BP)

MLP

BP

RBF

K

RBF

:( )

( )

( )

( )

(.)

( )

( ) .

( )

( )

(RMSE)

/ \* / m

(RBF)

MLP

RBF

rpm

hp

n

- 
1. Back Propagation
  2. Root Mean Square Error

...  
/ m/s

LoutronA-M-4202

± / m/s

%

$$M_2 = 1 - \frac{W_1(1 - M_1)}{W_2}$$

°C %

$M_1$   
 $M_2$  (%w.b.)  
 $W_1$  (%w.b.)  
 $W_2$  (g)  
(g)

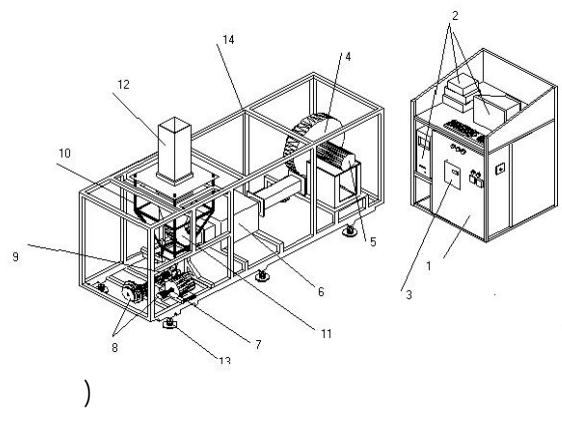

[ ] (

( )  
( )  
( )

kg

( ) ASAE  
% / ±

Neural Works Professional 11/PLUS (Ver. 5.23)

°C

( )

$m$  RBF

$$Y_i = \sum_{j=1}^m W_{ij} \exp\left(-\frac{\|x_i - c_j\|^2}{2\sigma_{ij}^2}\right) + b_j$$

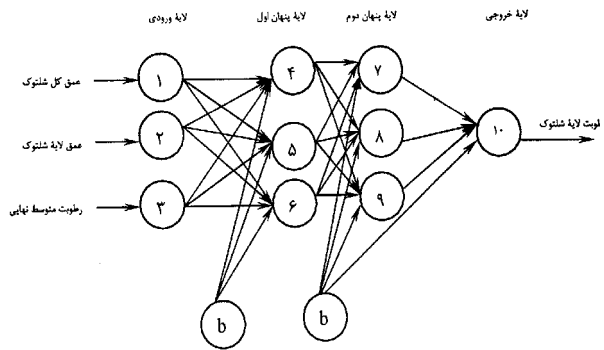
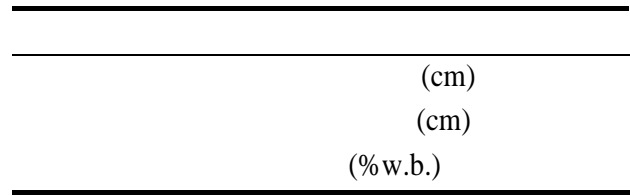

Ext DBD

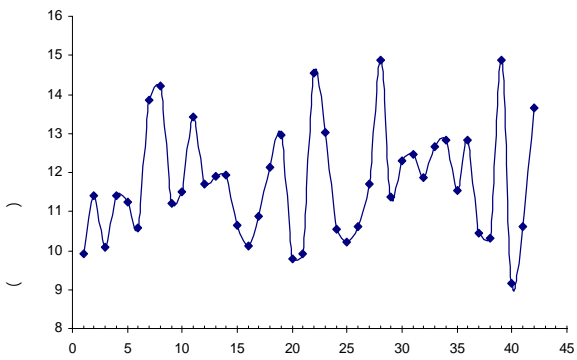

MLP :  
RBF

$$E_{RMS} = \sum_{p=1}^M \sum_{i=1}^N (S_{ip} - T_{ip})^2$$

1. Delta Rule
2. Norm-Cum-Delta Rule
3. Extended Delta-Bar-Delta Rule
4. Quick Propagation Rule
5. Max Propagation Rule
6. Delta-Bar-Delta Rule

$$Y_j = \sin(X_j)$$

$$Y_j = \frac{1}{1 + \exp(-X_j)}$$

$$Y_j = X_j$$

$$Y_j = \tanh(X_j)$$

$$X_j = \sum_{i=1}^m W_{ij} \times Y_i + b_j$$

$m$  MLP

$$b_j \quad i \quad Y_i \quad j \quad i \quad W_{ij}$$

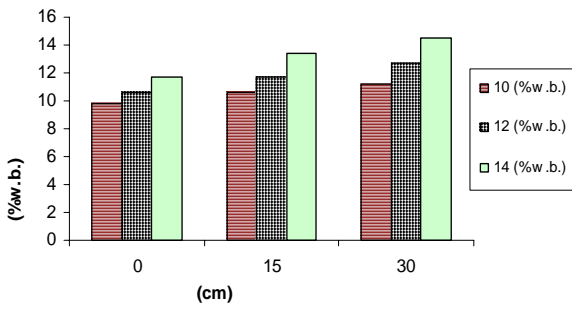
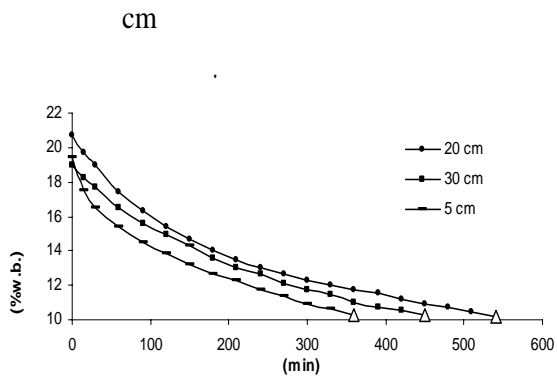

cm

RBF R<sup>2</sup> RMSE  
MLP

$$T_{ip} = \frac{E_{RMS}}{N} \quad S_{ip} = M$$

$$E_{MA} = \frac{1}{T} \sum_{k=1}^T |S_k - T_k|$$

$$SD_{E_{MA}} = \sqrt{\frac{\sum_{k=1}^T |S_k - T_k| - |S_k - T_k|}{T-1}}$$

$$X_n = \frac{X_i - X_{\min}}{X_{\max} - X_{\min}}$$

(MLP)

cm

$SD_{E_{MA}}$	$E_{MA}$	$R^2$	RMSE			
/	/	/	/	Delta Rule		
/	/	/	/	Ext DBD		
/	/	/	/	Ext DBD		
/	/	/	/	Ext DBD		
/	/	/	/	Ext DBD		
/	/	/	/	Norm-Cum-Delta		
/	/	/	/	Norm-Cum-Delta	Sin	RBF
/	/	/	/	Norm-Cum-Delta	Sin	
/	/	/	/	Ext DBD	Sin	
/	/	/	/	Ext DBD	Sin	
/	/	/	/	Delta Rule	TanH	
/	/	/	/	Delta Rule	Sigmoid	
/	/	/	/	Ext DBD	Sigmoid	
/	/	/	/	Delta Rule	Sin	
/	/	/	/	Norm-Cum-Delta	TanH	
/	/	/	/	Norm-Cum-Delta	TanH	
/	/	/	/	Norm-Cum-Delta	TanH	
/	/	/	/	Delta Rule	TanH	
/	/	/	/	Delta Rule	TanH	
/	/	/	/	Delta Rule	TanH	
/	/	/	/	Delta Rule	TanH	
/	/	/	/	Delta Rule	TanH	
/	/	/	/	Delta Rule	TanH	
/	/	/	/	Delta Rule	TanH	
/	/	/	/	Delta Rule	TanH	
/	/	/	/	Delta Rule	TanH	
/	/	/	/	Delta Rule	TanH	
/	/	/	/	Delta Rule	TanH	
/	/	/	/	Delta Rule	TanH	
/	/	/	/	Delta Rule	TanH	
/	/	/	/	Delta Rule	TanH	
/	/	/	/	Delta Rule	TanH	
/	/	/	/	Ext DBD	TanH	
/	/	/	/	Ext DBD	TanH	
/	/	/	/	Ext DBD	TanH	
/	/	/	/	Ext DBD	TanH	
/	/	/	/	Ext DBD	TanH	MLP
/	/	/	/	Ext DBD	TanH	
/	/	/	/	Delta Rule	Sigmoid	
/	/	/	/	Ext DBD	Sigmoid	
/	/	/	/	Delta Rule	Sin	
/	/	/	/	Delta Rule	Sin	
/	/	/	/	Delta Rule	Sin	
/	/	/	/	Delta Rule	Sin	
/	/	/	/	Delta Rule	Sin	
/	/	/	/	Ext DBD	Sin	
/	/	/	/	Ext DBD	Sin	



...

/

.( )

.( )

---

/

/

/

/

/

/

/

/

/

---

:

---

/

/

/

/

/

/

/

/

/

/

---

R<sup>2</sup> RMSE

( )

.( )

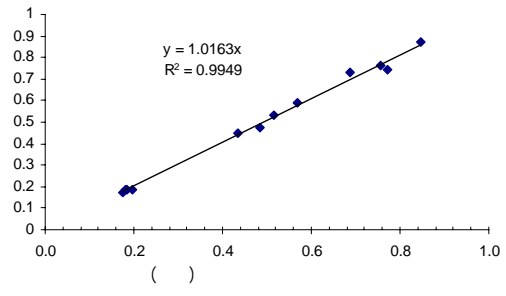
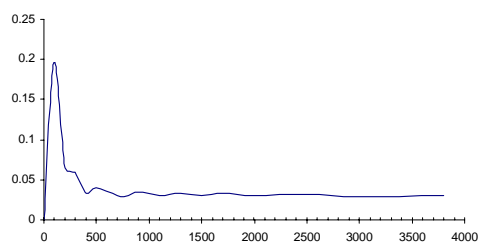

1. Over Training

MLP

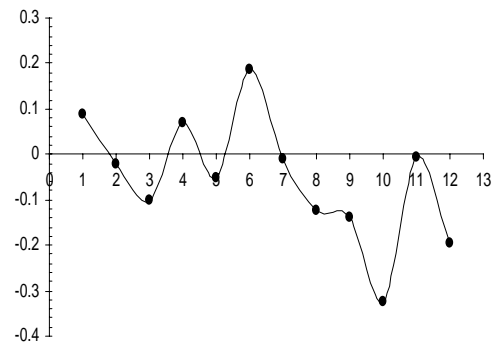

( )

( )

## REFERENCES

( ) ( )

2. ASAE. 2000. ASAE Standard S352.2: Moisture measurement-unground grain and seeds. 47<sup>th</sup> ed. ST. Joseph. MI: U.S.A.
3. Bonazzi, C., F. Courtois, B. Pons, M. C. Lahon, & J. J. Bimbenet. 1994. Experimental study on the quality of rough rice related to drying conditions. In: Proc. of the 9<sup>th</sup> International Drying Symposium, Gold Coast, Australia, Vol B (Drying 94): 1031-1035.
4. Broomhead, D. S. & D. Lowe. 1988. Multivariate functional interpolation and adaptive networks. *Complex Systems*, 2: 321-355.
5. Calderwood, D. I. 1971. Rice drying and storage studies. *The Rice Journal*, 74: 56-59.
6. Dayhoff, J. E. 1990. *Neural Networks Principles*. Prentice-Hall International, U.S.A.
7. Farkas, I., P. Remenyi & A. Biro. 2000a. Modeling aspects of grain drying with a neural network. *Computers and Electronics in Agriculture*, 29:99-113.
8. Farkas, I., P. Remenyi & A. Biro. 2000b. A neural network topology for modeling grain drying. *Computers and Electronics in Agriculture*, 26: 147-158.
9. Hall, C. W. 1980. *Drying and Storage of Agricultural Crops*. 1<sup>st</sup> ed. The AVI Publishing Co, Westport, Connecticut.

- ...
- :
10. Kaminski, W. & E. Tomczak. 1999. An integrated neural model for drying and degradation of selected products. *Drying Technology*, 17(7&8): 1291-1301.
  11. Khanna, T. 1990. *Foundations of Neural Networks*. Addison-Wesley Publishing Company, U.S.A.
  12. Peuty, M. A., A. Themelin, J. F. Cruz, G. Arnand, & J. P. Fohr. 1994. Improvement of paddy quality by optimization of drying conditions. In: *Proc. of the 9<sup>th</sup> International Drying Symposium, Gold Coast, Australia, Vol B (Drying 94)*: 929-935.
  13. Strohine, R. & D. Haman. 1994. *Physical Properties of Agricultural Materials and Food Products*. West Lafayette: Purdue University, U. S. A.
  14. Teter, N. 1987. *Paddy Drying Manual*. FAO, Rome.
  15. Zbicinski, I., P. Strumillo & W. Kaminski. 1996. Hybrid neural model of thermal drying in a fluidized bed. *Computers in Chemical Engineering*, (20): 695-700.

