

Application of Solar Energy for Drying of Sludge from Pharmaceutical Industrial Waste Water and Probable Reuse

Mehrdadi, N., ^{1*} Joshi, S. G., ² Nasrabadi, T. ¹ and Hoveidi, H. ¹

¹Department of Environment University of Tehran, Tehran, Iran

²Department of Civil Engineering, I.I.T, Bombay, India

Received 2 Aug 2006;

Revised 8 Oct 2006;

Accepted 5 Nov 2006

ABSTRACT: Sludge, which is produced as a by-product of all treatment processes, has considerable potential as a fertilizer and soil conditioner. Many authorities now discharge the sludge after treatment directly to agricultural land in liquid form, while some others dewater and dry it first. In either case, with proper marketing, it is generally possible for an authority to earn revenue by this means, although it is rare for the income to cover all the cost involved. In some industrial sludge the total solid concentration may range between 2000-100000 ppm and it is reported that more than 6000 waste water treatment plants use the conventional sludge drying sand bed. An experimental investigation was carried out to assess the efficacy of solar energy for drying of sludge from pharmaceutical industrial waste over a sand bed covered with glass as compared to the conventional sludge drying over a sand bed as well as to reduce environmental pollution. The two drying beds are constructed in 12 cm thick brick wall with cement mortar and has an effective area of 0.5 m². On the 0.4 m thick layer of gravel and sand the sludge layer from pharmaceutical industry was deposited. The Solar Sludge Drying Sand Bed (SSDSB) reduced drying time by about 25-35% as compared to the Conventional Sludge Drying Sand Bed (CSDSB). The rate of evaporation from the sludge surface and hence the drying was a function of solar radiation. The condensed evaporated water was qualitatively analyzed for probable reuse.

Key words: Solar energy, Pharmaceutical industry, Industrial sludge, Moisture, Glass cover, Probable reuse, Solids content, Environmental pollution

*Corresponding author E-mail: mehrdadi1@yahoo.com

INTRODUCTION

Sludge, which is produced as a by-product of all treatment processes, has considerable potential as a fertilizer and soil conditioner. The liquid sludge, which contains 90-98% water, can be partially dewatered by a number of processes. Dewatering and disposal of waste sludge is a major economical factor in the operation of wastewater treatment plants. Mikkelsen reported that 30-50% of the annual operating costs are related to sludge dewatering alone. We may define sludge handling to achieve: 1) a low sludge mass for disposal, in other words, a low solid mass and a high dry matter content of the dewatered sludge cake. 2) High dewatering rate. 3) Low conditioner dose. Most researches on sludge dewatering consider the filtration rate in terms of capillary suction time (CST) or specific resistance of filtration (SRF). It has often been observed, that the presence of dispersed particles has a negative effect on the filtration rate, regardless if the increase in dispersed particles is due to physical, chemical or biological

processes. The increased resistance is believed to be due to blinding of the filter medium of sludge cake with small particles. The total solid concentration may range between 2000-100,000 (ppm) in some industrial sludge. It is reported that over 6,000 wastewater plants use the conventional sludge drying sand bed and many cities with population of over 100,000 use sludge drying beds (Echenfelder and Santhanam, 1981). Present day drying bed design criteria are mainly based on solids content and volume of sludge. Important factors like solar Intensity, temperature, and wind velocity are neglected. Factors affecting the performance of drying beds include as:

1) Nature of sludge : Raw sludge and especially those containing a high amount of grease, tend to dry only slowly by evaporation above a dry solids content of about 30% but digested sludge normally crack more readily forming a highly fragmented cake which, in suitable weather, will dry to a dry solids content as high as 70%. Sludge which drains

readily leaves a cake of relatively uniform dry solids content but the one which drains slowly leaves a cake which is wet and stick to the lower layers and hard in surface crust.

2) Initial dry solids content of sludge: It is preferable to consolidate or thicken the sludge as much as possible before application in order to reduce the proportion of liquor which was to be removed by drainage, but the DS content must not be so high that the sludge will not flow to all parts of the bed.

3) Depth of application: The depth to which sludge is applied varies between 150 mm and 350 mm with mechanically lift beds. The depth of application is often 200 mm. If the applied depth is to shallow, the thickness of the sludge layer will be small and more applications will be required to deal with a given volume of sludge.

4) Weather conditions: Rain fall has a considerable effect on dewatering, especially before cracking. Evaporation is reduced in cloudy conditions because of low solar intensity but wind has a beneficial effect.

Little researches have been done in the utilization of solar energy for sludge drying. No information is available regarding the possible reuse of evaporated water from the sludge. E. Quon and Tambiyn (1985) utilized the radiant energy emitted by six 300 watt reflector flood light to dry sludge and found that the average rate of evaporation from a sludge surface was $0.89 \times 10^{-3} \text{ gm/cm}^2/\text{min}$ at the radiant intensity of $1.10 \text{ cal/cm}^2/\text{min}$. Chao, *et al.* (1982) studied a simple transparent structure similar to a green house which can be used to generate hot air from available solar energy for drying industrial sludge. The moisture content of 200 kg sludge could be reduced from 75% to around 30-33% in a five day operating period. Mikkelsen and Keiding (2002) established a model to characterize the relationship between EPS parameters and the dry matter content of filter cakes.

MATERIALS & METHODS

Two experimental beds were constructed to investigate drying of the sludge generated from the secondary clarifier under flow of a pharmaceutical industry. The glass covered bed is termed as solar sludge drying Bed (SSDSB) and the other functioned as Conventional Sludge Drying Sand Bed (CSDSB). The two drying beds are constructed in a 12 cm thick brick wall with cement mortar and have an effective area of 0.5 m^2 . On the 0.4 m thick layer of gravel and sand, the sludge layer is deposited. Temperature sensors are

provided at different heights for measuring the temperature behavior inside the systems as well as the roof cover. The SSDSB was covered with 3 mm window glass and the slope would yield maximum output when the year – round performance is considered. The top inside surface of the wall was coated with a special black coat to reduce the reflection of the surface and to increase its absorption of solar intensity. The solar intensity (I_t) was measured using a pyranometer attached to a millivoltmeter. The dimensions of the SSDSB are given in Fig. 1 (Mehrdadi and Joshi, 2002).

RESULTS & DISCUSSIONS

Activated sludge from secondary clarifier of pharmaceutical industry treatment plant was used for the determination of sludge drying time at a 60% dry solid content. The ranges of salient characteristics of the feed sludge are: pH 6.7-6.75; specific gravity 1.02-1.04; density 1020-1040 kg/m^3 ; MLSS 7500- 12,000 mg/L ; and MLVSS / MLSS 0.93-0.95. The following parameters were measured; hourly variation of solar radiation, temperatures at different heights within the beds of SSDSB and CSBSB, temperature of the glass, ambient temperature, humidity, wind velocity and yield of condensate water. Salient physical, chemical and bacteriological characteristics of condensate water are given in Table 1 in order to specify its drinking situation. It may be seen that all the quality parameters except Ammonia Nitrogen are well below the prescribed standards for drinking water and of excellent comparative quality with potable water. Ammonia concentration is higher as ammonia is evolved during anaerobic degradation which may occur in sand bed.

This was also noticed in similar studies carried out in a unit comprised of up flow anaerobic filter and solar depending in the reuse. It may be stated that such condensate can be reused for a variety of purposes. Results of a typical day for sludge design depth of 20 cm are presented in Fig. 2. In this Fig. parameters like hourly variation of solar intensity (I_t), ambient temperature, glass temperature, humidity percentage, wind velocity and distillate yield (M_e) are taken in to consideration. It is observed that the temperature build up within both reactors follow the solar radiation quite closely, reaching the peak of 48 degrees centigrade at 3.00 p.m. followed by a subsequent steep fall. However the bed temperature was always more by about 4 to 20 °C compared to the ambient temperature. The temperatures within the SSDSB were always more than those in CSDSB, favoring better conditions for drying.

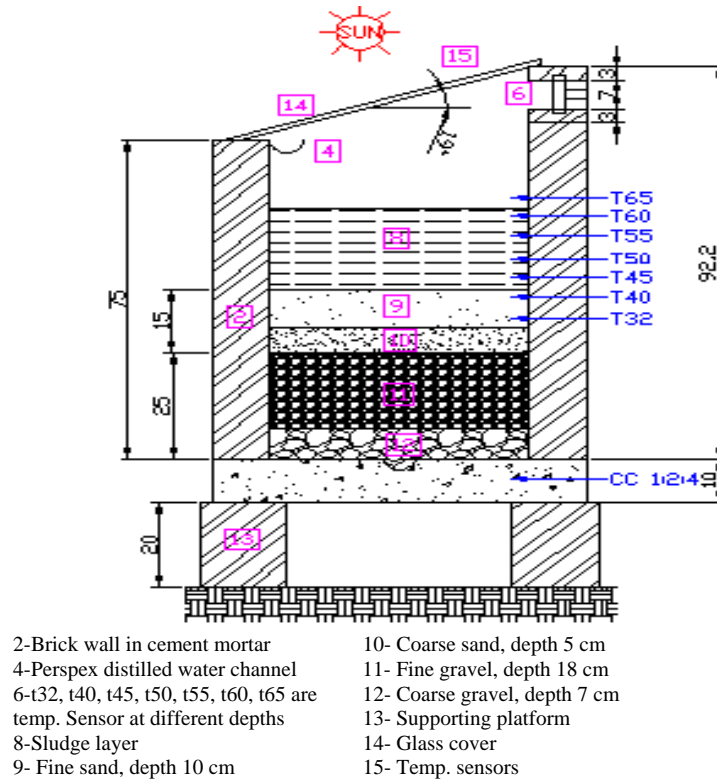

Fig. 1. A section of the Solar Sludge Drying Sand Bed (SSDSB)

Table 1. Characteristics of condensate water from (SSBSD) and tap water

Item	Condensate Quality Range	Tap water Range
Turbidity NTU	0-0.2	0 -0.5
pH	6.50-7.60	6.8-7.30
Conductivity Micromohs /cm	$1.5 \times 10^2 - 2 \times 10^2$	$2 \times 10^2 - 3 \times 10^2$
SS mg/L	NIL	NIL
TDS mg/L	0-20	--
Total hardness as CaCO ₃ mg/L	5-15	40-100
Permanent hardness as Ca CO ₃ mg/L	5-10	--
Chlorides as Cl mg/L	5-10	10-20
Alkalinity mg/L	10-20	30-80
Phosphorus mg/L	NIL	NIL
Ammonia Nitrogen mg/L	2-18	--
Iron mg/L	0.03-0.08	--
Total Bacteria Content / 100 mL	NIL	--
Coliform /100 mL	NIL	NIL

As it is shown in Fig. 3, distillation rate decreases as the sludge moisture content decreases with respect to time. The sludge moisture content in SSDSB was always less than the one in CSDSB being typically above 30% and 38.52% respectively at the end of 12 days of drying period. The effect of sludge dosing depth on sludge drying time to reach an appropriate condition at an average cake solid content of 60% is shown in Fig. 4. Even for 40% solid contents

under same weather conditions. The decrease in draying time is about 37.6 % and 34.40 % for SSDSB and CSDSB respectively, compared to 60% solid contents. As reported in literature. Salient results for percentage variation in solid contents for different sludge depths against time, along with the linear best fit equations are presented to the Fig. 5, which can be useful in the design of CSDSB and SSDSB.

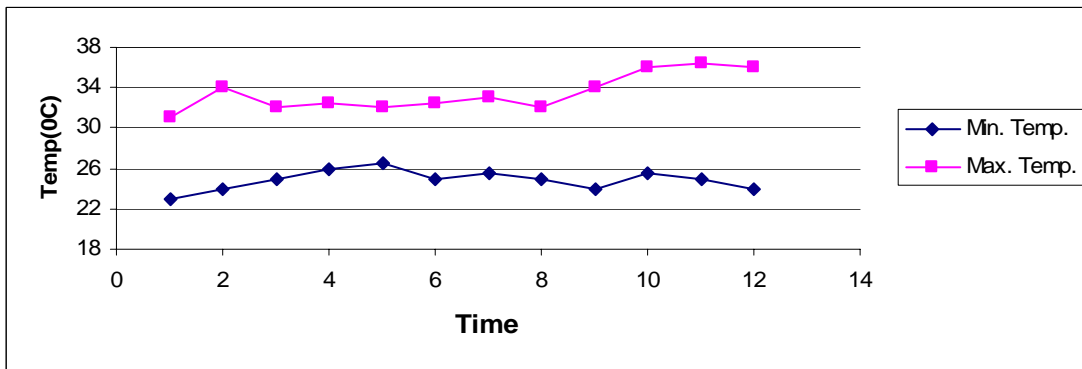
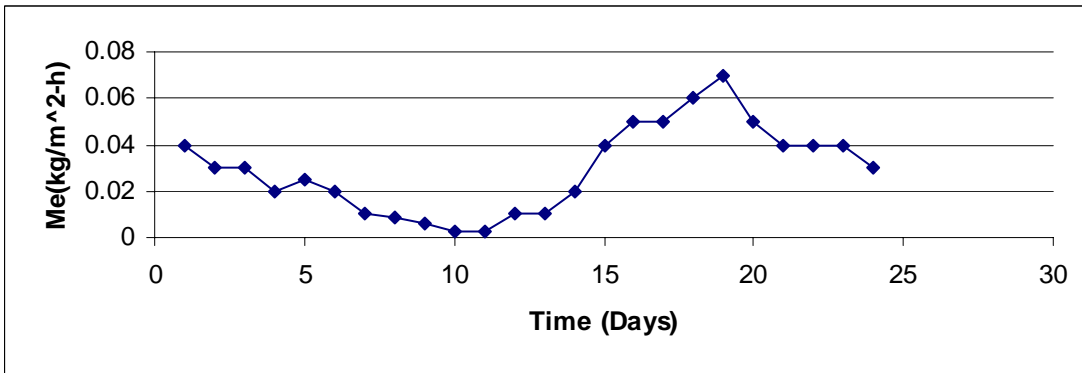
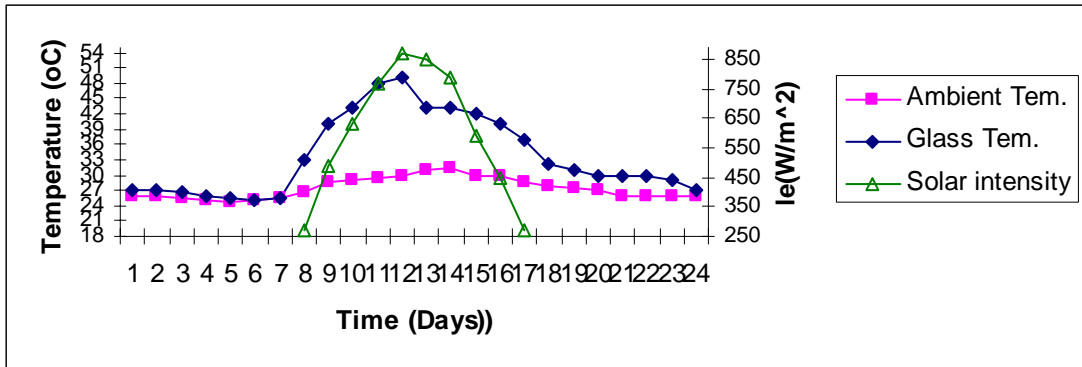

Fig. 2. Hourly variation of solar intensity (I_e), ambient temperature, glass temperature, humidity, wind velocity and distillate Yield (M_e) on 10th Oct. 1991

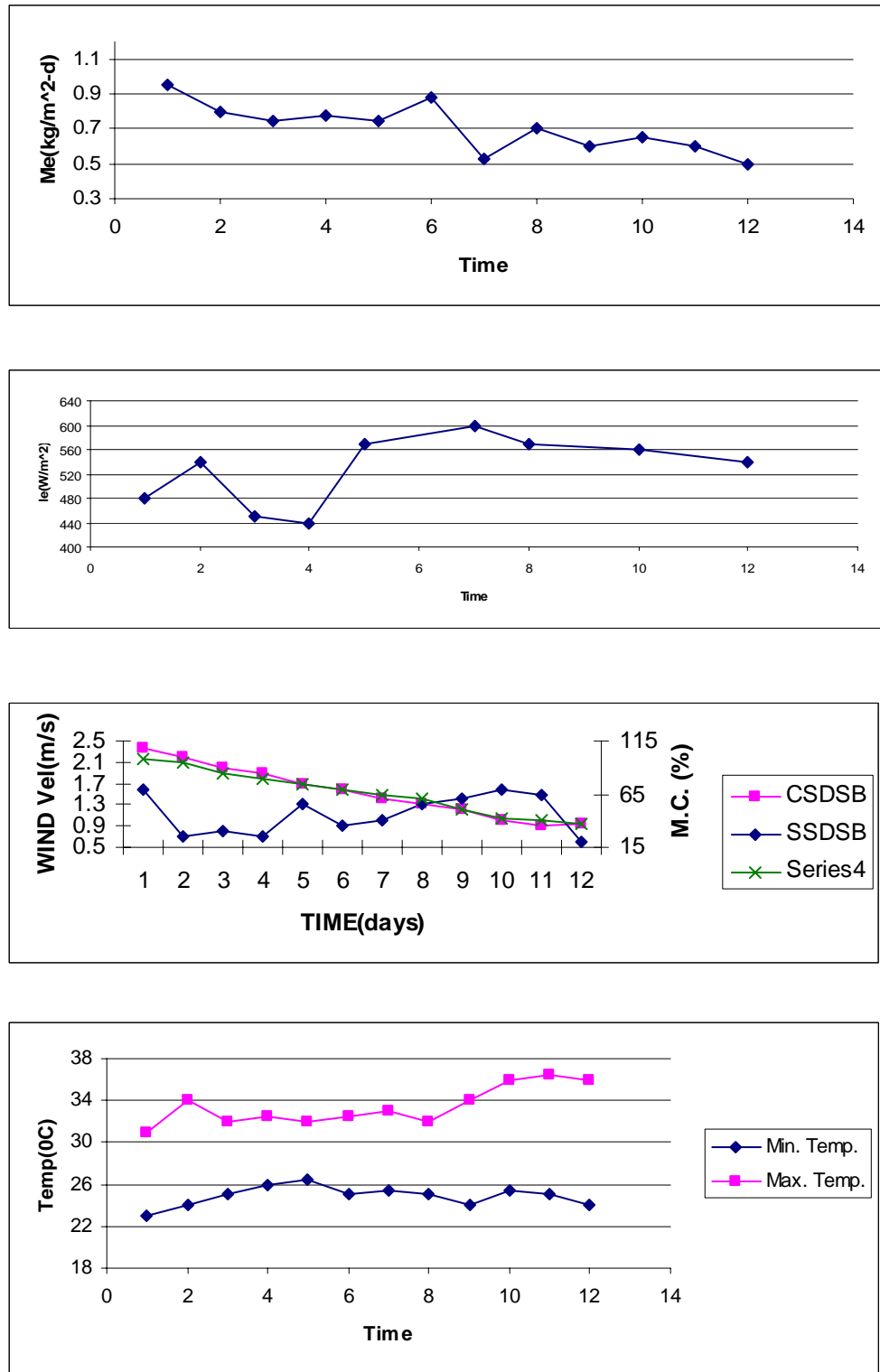

Fig. 3. Daily Variation of solar intensity (I_e), ambient temperature, humidity, wind velocity, distillate yield (M_e) and moisture content (MC) of SSDSB at a sludge depth of 20 cm

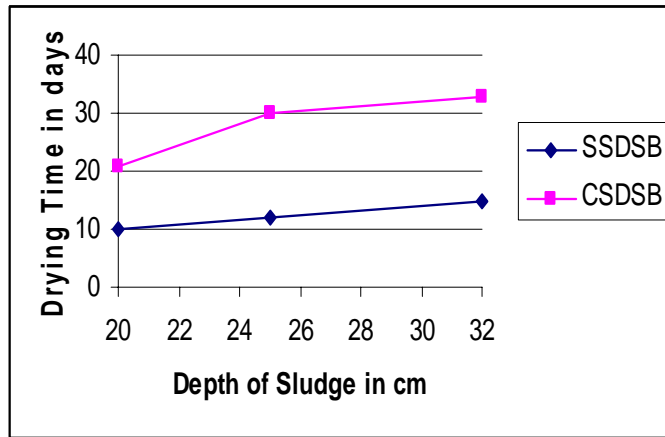

Fig. 4. Variation of drying time against sludge depth

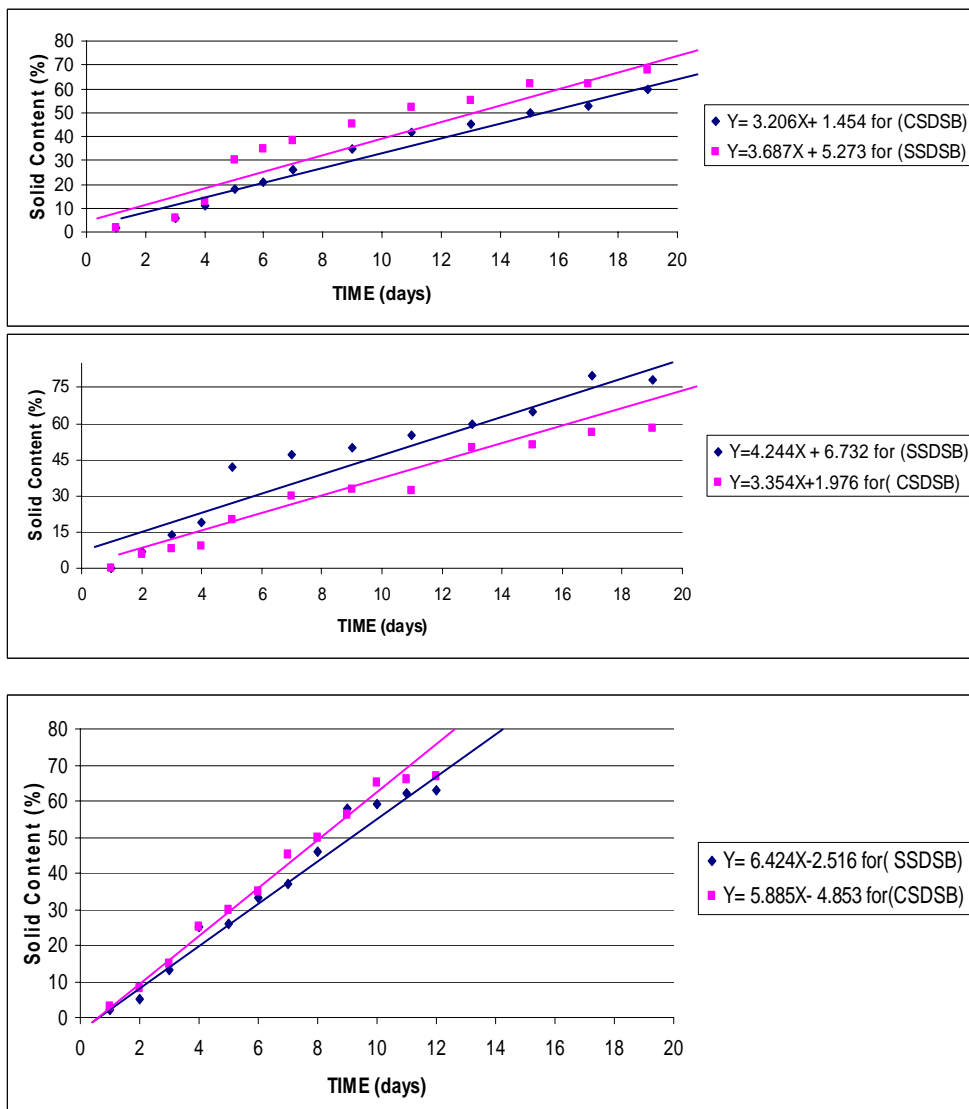

Fig. 5. Variation of solid content (%) against time at different depths of sludge in SSDSB and CSDSB reactors

CONCLUSION

Most of the moisture content was lost by drainage in first 3-4 days and the solar sludge drying sand bed reduced drying time by about 25-35% as compared to the conventional sludge drying sand bed. The sludge loading rates were observed to be about 138.5 kg solids/m²/year and 99.5 kg solids/m²/year for SSDSB and CSDSB respectively. Reuse of treated waste water finds best solution to solve the problem of water resources, potential utilization of solar energy for dual purposes of treatment of wastewater and obtaining reusable water including potable water as secondary products appears to offer new possibilities.

It may be concluded that the condensate water from SSDSB was of excellent quality for several probable reuses.

REFERENCES

- Chao, A. C., Fusakkaza A. and Watenabo, K., (1982). Using solar energy for drying industrial sludge in Japan, Proceedings of the 37th. Industrial Waste Conference, Purdue University.
- Echenfelder, W. Jr. and Santhanam, C. J., (1981). Sludge Treatment, Marcel Sehker Inc. New York.
- Mehrdadi, N. and Joshi, S. G., (2002). Concepts of Wastewater Reuse, 3rd. seminar on Science and Technology, December, New Delhi, India.
- Mehrdadi, N., Joshi, S. G. and Singh, J., (2001) Industrial wastewater Reuse – some case studies and experimental Investigation, Third International Seminar on Industrial Wastewater, September, Tehran, Iran.
- Mikkelsen, L. H. and Keiding, K., (2002). Physicochemical characteristics of full scale sewage sludge with implications to dewatering, Water Res., **36**.
- Quon, E. and Tambiyn, M., (1985). Intensity of radiation and rate of sludge drying, J. Sanitary, Eng. Division, ASCE., **91**, NO. SA2, .17- 31.